

# outdoor living

*the natural choice*



OUTDOOR ENTERTAINING | FURNITURE | ARBOURS | ARCHES  
PLANTERS | GROW YOUR OWN | TRELLIS | FENCING AND MORE...



# Award-winning user centred design at its best



## Stirling Arbour

Product Code: 36094

**Size: W x D x H**  
 2.12m x 1.44m x 2.10m  
 Posts: 70mm x 70mm  
 Trellis Panel: 120m x 0.39m  
 Table Top: 129m x 0.60m  
 Table Top: 30mm Thick  
 Seat Size: 128m x 0.20m  
 Pressure Treated

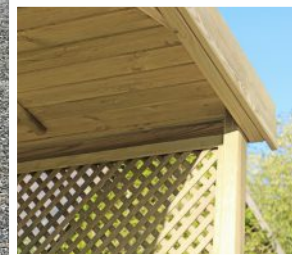

New from **zest** for 2024



**ITEMS MARKED WITH THE GOLD STAR ARE STOCKED IN STORE. ALL OTHER ITEMS CAN BE ORDERED QUICKLY INTO STORE**

Our timber products are all pressure or dip treated and many arrive flat packed and selected products arrive ready built. Products come with clear assembly instructions with selected lines having assembly videos accessed via the Zest website. Our furniture, decorative products and selected lines are guaranteed against rot for 10 years.

The key below will indicate if a product has special features:



**Pressure Treated & Guaranteed**  
 Made with quality Pressure Treated timber & backed by a 10 Year Guarantee Against Rot



**Pressure Treated**  
 Made with quality Pressure Treated timber



**Dip Treated**  
 Timber has been dipped rather than Pressure Treated



**Home Delivery**  
 Products are available for delivery to a home address



**Flat Packed**  
 Products are supplied flat packed with assembly instructions



**Easy Build**  
 Products are supplied flat packed & designed for easy assembly



**Ready Built**  
 Products with this symbol have been Ready Built - no assembly required



**Animated Assembly**  
 Products with this symbol have an assembly video online



**Made in Britain**  
 Products with this symbol have been Manufactured in Britain



**Designed in Britain**  
 Products with this symbol have been Designed in Britain

All sizes where quoted are approximate and in metric. Products have been measured to maximum exterior dimensions including roof overhang unless otherwise stated. Our policy is one of continuous improvement. We therefore reserve the right to modify product designs and specifications without prior notice.

Every effort has been made to provide up-to-date factual information, but, as our policy is one of continual improvement we reserve the right to modify or change specifications as necessary. No liability will be accepted for errors and omissions. All guarantees are conditional and if you are in any doubt as to the terms and conditions, please feel free to contact us. All sizes, where quoted, are approximate and in metric. Products have been measured to maximum exterior dimensions including roof overhang unless otherwise stated. Some specifications may vary due to availability and product improvements. Colour has been applied to some products for photographic purposes only. We take great care in the photographic accuracy of products shown in our brochure, however, due to variables in both photographic and printed processes and the natural characteristics of wood, colours may not exactly match the actual products. All orders below minimum carriage paid will incur a delivery charge. Speak to your Account Manager for details.





## Noah's Arbour

Product Code: 15214

Size: W x D x H  
 2.16m x 1.78m x 2.36m  
 Posts: 70mm x 70mm  
 Trellis Panel: 128m x 0.50m  
 Table Top: 153m x 0.70m  
 Table Top: 30mm Thick  
 Seat Size: 153m x 0.35m  
 Pressure Treated



## Brighton Corner Arbour

Product Code: 00036

Size: W x D x H  
 2.20m x 2.20m x 2.49m  
 Posts: 68mm x 68mm  
 Slats: 35mm  
 Seat: 65mm x 35mm  
 Pressure Treated







## Hampshire Arbour with storage box

Product Code: 00403

Size: W x D x H  
 1.97m x 0.63m x 2.06m  
 Posts: 70mm x 45mm  
 Roof: 90mm x 14mm  
 Fascia: 18mm  
 Seating: 70mm x 35mm  
 Seat Size: 150m x 0.35m  
 Box Size: 150m x 0.54m  
 Pressure Treated



### Optional Extras:

Product Code	Description	Size
00594	Green Pad	15m x 0.37m
00595	Stone Pad	15m x 0.37m
00404	Cover	



## Dorset Arbour with storage box

Product Code: 00035

Size: W x D x H  
 1.56m x 0.67m x 1.99m  
 Posts: 70mm x 45mm  
 Roof: 10mm Combined Finish Board  
 Fascia: 18mm Bowed Fascia  
 Panels: 10mm Shiplap  
 Trellis Panels: 20mm x 8mm  
 Seat Size: 120m x 0.35m  
 Box Size: 120m x 0.54m  
 Pressure Treated



### Optional Extras:

Product Code	Description	Size
00401	Green Pad	12m x 0.37m
00627	Stone Pad	12m x 0.37m
00371	Cover	







## Chepstow Arbour

Product Code: 25224

Size: W x D x H

1.44m x 0.66m x 2.23m

Posts: 70mm x 45mm

Roof: 10mm Combined Finish Board

Fascia: 22mm Bowed

Side & Back Trellis Panels: 20mm x 8mm

Seat Size: 120m x 0.48m

Pressure Treated

### Optional Extras:

Product Code	Description	Size
00401	Green Pad	12m x 0.37m
00627	Stone Pad	12m x 0.37m
00343	Cover	



## Cheltenham Arbour with storage box

Product Code: 00342

Size: W x D x H

1.44m x 0.66m x 2.23m

Posts: 70mm x 45mm

Roof: 10mm Combined Finish Board

Fascia: 22mm Bowed

Side & Back Panels: 10mm shi lap

Seating: 70mm x 35mm

Seat Size: 120m x 0.35m

Box Size: 120m x 0.54m

Pressure Treated

### Optional Extras:

Product Code	Description	Size
00401	Green Pad	12m x 0.37m
00627	Stone Pad	12m x 0.37m
00343	Cover	







## Tenby Arbour

Product Code: 25222

Size: W x D x H  
 2.07m x 0.85m x 2.07m  
 Frame: 88mm x 44mm  
 Roof: 18mm  
 Fascia: 20mm  
 Side & Back Panels: 10mm  
 Seating: 40mm x 28mm  
 Seat Size: 144m x 0.50m  
 Pressure Treated



10TH ANNUAL  
**GIMA**  
 AWARDS  
 2021  
 FINALIST

## Burghley Arbour

Product Code: 25223

Size: W x D x H  
 2.07m x 1.18m x 2.07m  
 Frame: 90mm x 45mm  
 Roof: 18mm  
 Fascia: 20mm  
 Side & Back Panels: 10mm  
 Seating: 40mm x 28mm  
 Seat size: 144m x 0.50m  
 Pressure Treated





# Gazebos

Providing the perfect setting to relax with family and friends outdoors. Cleverly designed, these gazebos offer total flexibility with a choice of trellis and panels to suit individual needs



## The Tatton Gazebo

Product Code: 00629

Size: W x D x H  
2.64m x 2.64m x 2.49m

For locations where additional privacy or extra shelter is required, the Tatton fits the bill. Three solid tongue and groove panels provide a solid backdrop to the building and two balustraded sections are included for each side of the entrance. You can replace the balustrade sections at the front with any combinations of the other panels for an additional charge.



Gazebo bench is an optional extra



## The Clifton Gazebo

Product Code: 09650

Size: W x D x H  
2.64m x 2.64m x 2.49m

This beautifully designed gazebo has a solid tongue and groove panel at the back with diamond trellis either side and balustrade sections each side of the entrance. Add an additional trellis panel at the rear rather than the solid panel without cost to give 360 degree views from your gazebo.



Gazebo bench is an optional extra



## The Moreton Gazebo

Product Code: 00503

Size: W x D x H  
2.64m x 2.64m x 2.49m

The Moreton Gazebo with square trellis is a great feature for any garden with your favourite climbing plants entwined through the attractive pressure treated timberwork. Add an additional trellis panel at the rear rather than the solid panel without cost to give 360 degree views from your gazebo.



Gazebo bench is an optional extra



# BBQ Shelters & Pavilions

Providing the perfect setting to relax and cook with family and friends outdoors



**Ashton BBQ Shelter**  
Product Code: 00038

Size: W x D x H  
2.20m x 1.35m x 2.14m  
Roof Slats: 85mm x 16mm  
Pressure Treated



**Broxton BBQ Shelter**  
Product Code: 00037

Size: W x D x H  
2.20m x 2.20m x 2.49m  
Posts: 68mm x 68mm  
Side Panel Slats: 65mm x 12mm  
Side Panel Frame: 35mm x 30mm  
Roof Slats: 85mm x 16mm  
Pressure Treated



**Knutsford Pavilion**

Code	Name	Size: W x D x H
15221	2.4m	2.80m x 2.80m x 2.30m
15220	3m	3.32m x 3.32m x 2.53m

Posts: 70mm x 70mm  
Side Panel Slats: 70mm x 16mm  
Side Panel Frame: 70mm x 16mm  
Ring Beam: 70mm x 70mm  
Roof Slats: 120mm x 18mm  
Pressure Treated



Perfectly fits the  
Terraza Outdoor  
Kitchen Set

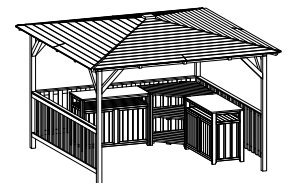





# Outdoor Entertaining

The outdoor entertaining range has been created in response to increased consumer demand for outdoor living and entertaining. Both stylish and functional, the collection provides innovative solutions for entertaining family and friends in the garden, effortlessly transforming any outdoor space.



## Garden Pizza Oven Table

Product Code: 31315

Size: W x D x H  
0.73m x 0.83m x 0.88m  
Sides: 0.47m x 0.7m  
Frame: 70mm x 30mm  
Pressure Treated





## Garden Bar & 2 Stool Set

Product Code: 35079

Size: W x D x H

1.56m x 0.67m x 2.00m

Posts: 70mm x 45mm

Roof: 10mm Combined Finish Board

Fascia: 8mm

Panels: 10mm Shiplap

Pressure Treated

### Optional Extras:

Product Code	Description
00371	Cover



## BBQ Side Table

Product Code: 00314

Size: W x D x H

0.91m x 0.52m x 0.85m

Table Top: 17mm Thick

Legs: 57mm x 17mm

Pressure Treated



## Folding Garden Bar

Product Code: 29733

Size: W x D x H

1.09m x 0.45m x 0.98m

Table Top: 105mm x 0.43m

Side & Back Panels: 20mm Thick

Fascia: 20mm Thick

Bracing: 20mm Thick

Pressure Treated



Also ideal as a Potting Table





## Alfresco living

Absolutely on trend for outdoor entertaining, the Terraza Outdoor Kitchen provides a sustainable route to alfresco cooking and one which will blend into the garden beautifully. Designed in the UK and made from PEFC sustainable slow grown soft wood from responsibly managed forests and with a 10 year guarantee against rot, all products in the Terraza Outdoor Kitchen range can be purchased individually or as a set comprising two double units and a display corner unit. There is also an optional side table to extend the serving space.

The double kitchen unit offers ample storage for tools and cooking equipment. The additional open sided top shelf is ideal for serving utensils. It comes with a stainless steel top which is perfect for food preparation. The corner unit provides masses of storage and is also perfect for setting up a pizza oven and is the standard working height you would find in an indoor kitchen. Delivered flat packed, the Terraza Outdoor Kitchen can be easily assembled on a firm solid ground to give years of outdoor enjoyment.

All items coordinate with existing Zest outdoor entertaining products including the Zest Garden Bar and Two Stool Set and the Zest Garden Pizza Oven Table to create the perfect natural outdoor kitchen and entertaining area.

# Terraza Outdoor Kitchen Set

*Side Table available as an optional extra*

2x Double Units

1x Corner

Product Code: 38341





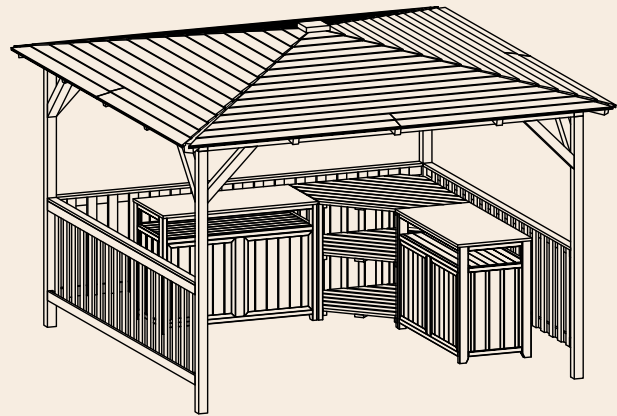
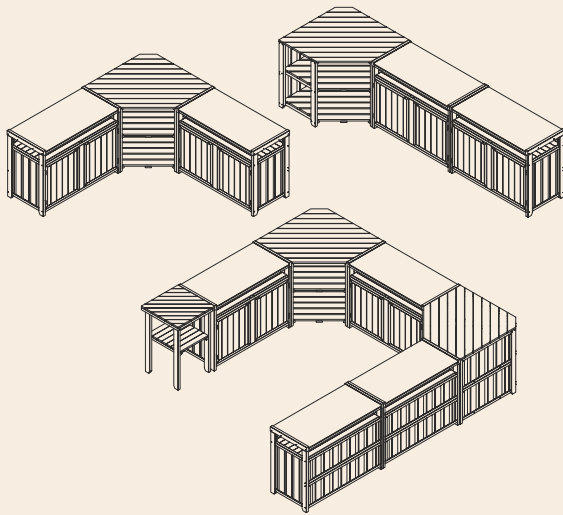

Fits perfectly under the Knutsford Pavilion 3m

## Modular design to fit any garden space

The modular style of the Terraza range is ideal for creating the perfect outdoor kitchen based on the size of a garden. Units fit together with ease to create a perfect alfresco space. The modular format of the Terraza Outdoor Kitchen Set fits effortlessly under the Knutsford Pavilion 3m.



## Terraza Outdoor Kitchen Range

A Double Unit

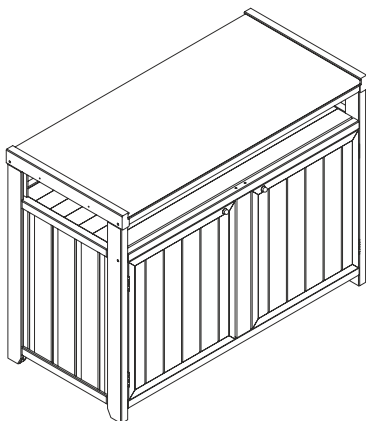

Product Code: 36101  
Size: W x D x H  
1.21m x 0.58m x 0.89m

B Corner Unit

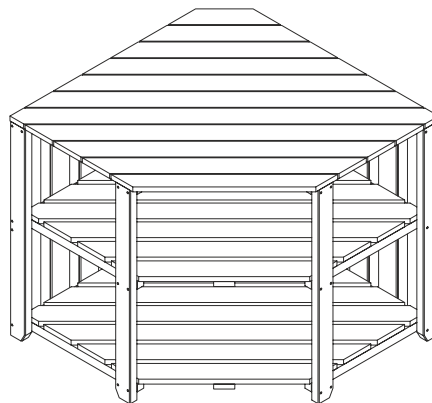

Product Code: 36102  
Size: W x D x H  
1.00m x 1.00m x 0.89m

C Side Table

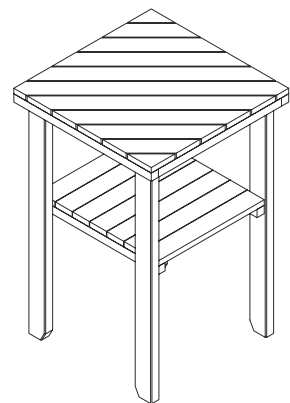

Product Code: 36103  
Size: W x D x H  
0.58m x 0.58m x 0.89m





# Furniture

People now use their gardens more for outdoor living and socialising as well as a sanctuary for their wellbeing. Zest's quality range of timber garden furniture focuses on design, comfort, low maintenance, and easy assembly. Perfect for relaxing, unwinding outdoors and entertaining family and friends.



## Jasmine Folding Chair

Dark Grey Product Code: 27643

Light Grey Product Code: 27644

Size: W x D x H

0.67m x 0.80m x 0.88m

Folds away for easy storage.  
Available in Dark & Light Grey





# Lily Relax Range

Enjoy your free time in the garden with the Lily Relax range. Designed for maximum comfort, it has an angled back and a wider arm rest support. Choose from the double seat incorporating a handy table for refreshments, a single seat, a rocking chair, a side table and a matching foot stool.



## Lily Relax Double Seat

Product Code: 00450

Footstool Sold Separately

Size: W x D x H

Seat: 1.75m x 0.92m x 0.92m

Frame: 30mm Thick

Seat: 18mm Thick

Pressure Treated



## Lily Relax Foot Stool

Product Code: 00451

Size: W x D x H

0.51m x 0.59m x 0.38m

Pressure Treated



## Lily Relax Side Table

Product Code: 00455

Size: W x D x H

0.47m x 0.47m x 0.55m

Table top: 18mm Thick

Legs: 90mm x 30mm

Pressure Treated



## Lily Relax Rocking Chair

Product Code: 09657

Size: W x D x H

0.72m x 1.14m x 0.99m

Frame: 30mm Thick

Seat: 18mm Thick

Rockers: 110mm x 58mm

Pressure Treated



## Lily Relax Seat

Product Code: 00452

Size: W x D x H

0.72m x 0.92m x 0.92m

Frame: 30mm Thick

Seat: 18mm Thick

Pressure Treated





# Seating

Sit and take a moment to relax in the garden with classic and contemporary wooden garden benches designed for comfort, style and easy assembly.



## Cherry Blossom Bench

Product Code: 29990

Size: W x D x H  
 1.45m x 0.65m x 0.92m  
 Frame: 70mm x 70mm  
 Seat: 55mm x 20mm  
 Pressure Treated



## Caroline Companion Seat

Product Code: 00010

Size: W x D x H  
 1.94m x 0.79m x 0.94m  
 Seat: 30mm Thick  
 Table Top: 25mm Thick  
 Hole for Parasol  
 Pressure Treated



## Millie Bench

Product Code: 16491

Size: W x D x H  
 1.2m x 0.80m x 0.90m  
 Frame: 200mm x 40mm  
 Seat: 45mm x 40mm  
 Back: 45mm x 40mm  
 Pressure Treated





# Picnic Tables

In a choice of sizes and styles and with fixed benches or seats, Zest's range of wooden picnic tables are suitable for gardens, patios and smaller outdoor spaces.



## Katrina Picnic Table

Product Code: 00439

Size: W x D x H  
**1.60m x 1.50m x 0.73m**  
 Table Top: 16m x 0.72m  
 Table & Seat Thickness: 38mm  
 Frame: 80mm x 40mm  
 Pressure Treated



## Rose Round Picnic Table

Product Code: 00006

Size: W x D x H  
**2.10m Diameter x 0.75m**  
 Table Top: 135m Diameter  
 Table & Seat Thickness: 38mm  
 Frame: 40mm x 38mm  
 Hole for Parasol: 40mm Diameter  
 Pressure Treated



## Katie Round Picnic Table

Product Code: 00438

Size: W x D x H  
**1.47m Diameter x 0.72m**  
 Table top: 0.80m Diameter  
 Table and Seats: 30mm Thick  
 Frame: 30mm Thick  
 Hole for Parasol: 40mm Diameter  
 Pressure Treated





# Dining Sets & Furniture Ranges

For quality time with family and friends, and equally good for parties and socialising, Zest's outdoor wooden dining sets are designed for the ultimate outdoor living experience.



## Philippa Dining Set

### Table, 2 Benches & 2 Chairs

The Philippa Dining Set is both solid and comfortable and is designed with modern outdoor living in mind. The set comes complete with a large table, two, three seater benches, and two extra wide end chairs, making this the perfect addition to any garden. An ideal set for entertaining larger groups of family and friends

### Philippa Dining Set

Product Code: 00007

Name	Size: W x D x H
Table	1.60m x 0.76m x 0.76m
Bench	1.60m x 0.45m x 0.917m
Chair	0.75m x 0.45m x 0.917m

Table Top Size: 38mm      Frame: 90mm x 38mm  
Legs: 90mm x 90mm      Pressure Treated







## Rebecca Set

Table & 2 Benches

Code	Name	Size: W x D x H
00004	Table	1.80m x 0.72m x 0.75m
00005	Bench	1.80m x 0.24m x 0.43m

Table Top: 170mm x 60mm

Legs: 170mm x 60mm

Pressure Treated

The handcrafted rustic design of the Rebecca set will fit beautifully into any garden. The solid set offers a traditional bench and two spacious stools. Ideal for al fresco dining or enjoying long summer evenings with family or friends.



## Harriet Dining Set

Table & 2 Benches

Code	Name	Size: W x D x H
09658	Set	1.60m x 2.00m x 0.86m
00409	Table	1.60m x 0.76m x 0.75m
00407	Bench	1.60m x 0.62m x 0.86m

Table Top: 160mm x 76mm

Legs: 40mm Thick

Pressure Treated

Perfect for dining al fresco with friends and family, this timber dining set looks stylish in any garden or outdoor space. Featuring a sturdy table and two benches that can comfortably seat six people, whether gathered round for a BBQ or simply a glass of wine with friends.







# Emily Dining & Seating Range

The classically styled Emily range includes a sturdy yet elegant table and two-bench dining set, a chair, a beautiful bench in a choice of sizes, a handy side table and the ever popular Love Seat. The Emily Dining Set is designed for comfort and style, with contoured arms and a solid dining table, ideal for entertaining family and friends. Built to stand the test of time.

## Table & 2 Bench Set Product Code: 00382

Size: W x D x H  
1.60m x 2.06m x 0.935m  
Table Top: 145mm x 38mm  
Legs: 65mm Thick  
Set: Table & 2x 4ft Benches  
Pressure Treated







## Emily Benches

<b>Product Code</b>	<b>Name</b>	<b>Size: W x D x H</b>
00009	2 Seater	1.23m x 0.65m x 0.935m
00008	3 Seater	1.53m x 0.65m x 0.935m

Frame: 70mm x 70mm  
 Seat: 55mm x 20mm  
 Pressure Treated



SEAT PADS ARE AVAILABLE  
 IN GREY AND GREEN



## Emily Love Seat

Product Code: 00379

**Size: W x D x H**  
 1.94m x 0.83m x 0.935m  
 Seat: 55mm x 20mm  
 Table Top: 25mm Thick  
 Hole for Parasol: 40mm Diameter  
 Pressure Treated



## Emily Chair

Product Code: 00376

**Size: W x D x H**  
 0.64m x 0.65m x 0.935m  
 Frame: 70mm x 70mm  
 Seat: 55mm x 20mm  
 Pressure Treated



## Emily Side Table

Product Code: 00380

**Size: W x D x H**  
 0.60m x 0.60m x 0.60m  
 Table Top: 145mm x 38mm  
 Legs: 65mm Thick  
 Pressure Treated



## Emily Table

Product Code: 00381

**Size: W x D x H**  
 1.60m x 0.76m x 0.76m  
 Table Top: 145mm x 38mm  
 Legs: 65mm Thick  
 Pressure Treated







Rectangular Table, 2 Benches &amp; 2 Chairs



# Freya Dining & Seating Range

The Freya range presents a new design aesthetic and incorporates alternate width wooden slats cleverly spaced to make a very comfortable ergonomic seating shape. The extended high back improves comfort and support but also gives a sense of drama and presence to the outdoor dining experience. The encompassing style and presence of the Freya Dining Set offers the customer value for money through good design and premium appearance.

All details of the product have been considered, particularly the width and length of the arm rests, which provide maximum arm support as well as allowing space to rest a glass with a modern and contemporary look.

## Freya 6 Seater Dining Set Set Product Code: 33969

**Size: W x D x H**  
**3.10m x 2.40m x 1.06m**  
 Table Top: 120mm x 30mm Boards  
 Legs: 70mm x 40mm  
 Frame: 70mm x 35mm  
 Seat: 30mm x 20mm  
 70mm x 20mm Slats  
 Arm Width: 90mm  
 Pressure Treated





## Freya 4 Seater Dining Set

Set Product Code: 33970

Size: W x D x H

1.50m x 2.40m x 1.06m

Table Top: 120mm x 30mm Boards

Legs: 40mm x 70mm

Frame: 70mm x 35mm

Seat: 30mm x 20mm

70mm x 20mm Slats

Arm Width: 90mm

Pressure Treated



Rectangular Table, Bench & 2 Chairs

## Freya Rectangle Table

Product Code: 33975

Size: W x D x H

1.50m x 0.75m x 0.75m

Table Top: 120mm x 30mm Boards

Legs: 70mm x 40mm

Pressure Treated

## Freya Round Table

Product Code: 33976

Size: W x D x H

1.0m Diameter x 0.75m

Table Top: 120mm x 30mm Boards

Legs: 70mm x 40mm

Pressure Treated

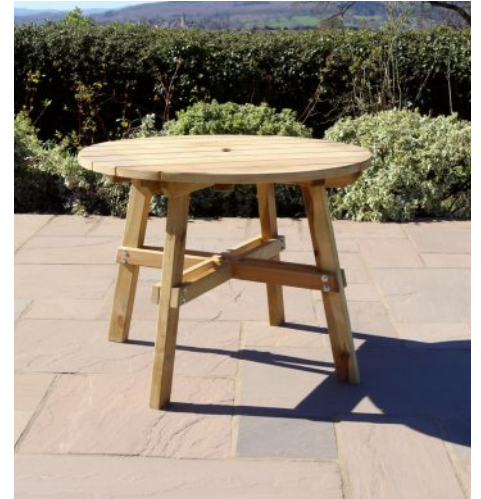

## Freya Round Dining Set

Set Product Code: 33971

Size: W x D x H

2.50m Diameter x 1.06m

Table Top: 120mm x 30mm Boards

Legs: 70mm x 40mm

Frame: 70mm x 35mm

Seat: 30mm x 20mm

70mm x 20mm Slats

Arm Width: 90mm

Pressure Treated



Round Table & 4 Chairs





### Freya Chair

Product Code: 33977

Size: W x D x H  
 0.68m x 0.77m x 1.06m  
 Frame: 70mm x 35mm  
 Seat: 30mm x 20mm  
 70mm x 20mm Slats  
 Arm Width: 90mm  
 Pressure Treated



### Freya Companion Seat

Product Code: 33974

Size: W x D x H  
 1.90m x 0.95m x 1.06m  
 Frame: 70mm x 35mm  
 Seat: 30mm x 20mm  
 70mm x 20mm Slats  
 Arm Width: 90mm  
 Pressure Treated



### Freya 2 Seater Bench

Product Code: 33973

Size: W x D x H  
 1.19m x 0.77m x 1.06m  
 Frame: 70mm x 35mm  
 Seat: 30mm x 20mm  
 70mm x 20mm Slats  
 Arm Width: 90mm  
 Pressure Treated



### Freya 3 Seater Bench

Product Code: 33972

Size: W x D x H  
 1.68m x 0.77m x 1.06m  
 Frame: 70mm x 35mm  
 Seat: 30mm x 20mm  
 70mm x 20mm Slats  
 Arm Width: 90mm  
 Pressure Treated







# Swing Seats

Zest offers a choice of swings in response to increased demand in the market. Ergonomically designed, the swings offer comfort and create a focal point in any garden. With chrome plated chains for support and made from sturdy PEFC sourced timber, the swings are built to stand the test of time.



## Santorini Swing

Product Code: 20772

Size: W x D x H  
**1.89m x 1.50m x 1.70m**  
 Posts: 70mm x 70mm  
 Top Beam: 120mm x 40mm  
 Diagonal Beams: 70mm x 30mm  
 Roof Slats: 70mm x 25mm  
 Seat Slats: 45mm x 35mm  
 Pressure Treated



## Miami Swing

Product Code	Name	Size: W x D x H
00496	2 Seater	1.89m x 1.62m x 1.80m
15216	3 Seater	2.20m x 1.62m x 1.80m

Posts: 70mm x 70mm  
 Diagonal Beams: 70mm x 30mm  
 Seat Slats: 45mm x 35mm  
 Top Beam: 150mm x 45mm  
 Pressure Treated



## Swing Optional Extras:

Product Code	Description	Size
00596	2 Seat Green Pad	12m x 0.45m
00597	2 Seat Stone Pad	12m x 0.45m
15256	3 Seat Green Pad	15m x 0.45m
15257	3 Seat Stone Pad	15m x 0.45m
00498	2 Seat Cover	



ONLY AVAILABLE FOR MIAMI 2 SEATER





# Grow Your Own & Planters

The popular and practical Grow Your Own and Planter range has everything needed to grow your own produce and flowers with ease.



## 4 Tier Raised Bed

Product Code: 31321

Size: W x D x H  
**0.96m x 0.96m x 0.83m**  
 Sides: 100mm x 30mm  
 Top Trim: 60mm x 30mm  
 Pressure Treated

### Optional Extras:

Product Code	Description	Size
00311	Base	0.83m x 0.83m

**370L**  
Compost





# Grow Your Own

The award-winning range has everything you need to grow your own. Perfect for beginners or experts, the popular range is ideal for herbs, vegetables or flowering plants.



## Deep Root Planter

Product Code	Name	Size: W x D x H
00365	1m	1.0m x 0.70m x 0.80m
00364	1.8m	1.8m x 0.70m x 0.80m

Timber Sides: 18mm  
 Legs: 75mm x 22mm  
 Top Trim: 75mm x 22mm  
 Growing Depth: 380mm Approx.  
 Pressure Treated

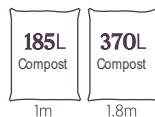

## Veg Bed

Product Code	Name	Size: W x D x H
00648	1m	1.0m x 0.77m x 0.84m
00649	2m	2.0m x 0.77m x 0.84m

Sides & Ends: 18mm Thick  
 Legs: 70mm x 45mm  
 Growing Depth: 150mm - 450mm Approx.  
 Pressure Treated

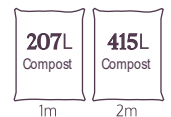

## Raised Herb Planter

Product Code: 20781

Designed to fit the Small-Space Cold Frame

Size: W x D x H  
 1.22m x 0.60m x 0.85m  
 Side Frame: 45mm x 45mm  
 Legs: 45mm x 45mm  
 Pressure Treated

The Small-Space Cold Frame will not only work as a standalone cold frame but has also been designed to fit onto the Raised Herb Planter to create the added benefit of easy access and increased depth for planting.



## Small-Space Cold Frame

Product Code: 29731

Designed to fit the Raised Herb Planter

Size: W x D x H  
 1.22m x 0.60m x 0.355m  
 Frame: 45mm Thick  
 Internal Slats: 15mm Thick  
 Lid: Acrylic Glazing  
 Pressure Treated







**Sleeper Cold Frame**  
Product Code: 00606

Size: W x D x H  
1.70m x 0.60m x 0.43m/0.32m  
Interlocking Sides: 30mm Thick  
Lid: Acrylic Glazing  
Pressure Treated



**Large Cold Frame**  
Product Code: 00442

Size: W x D x H  
1.67m x 0.50m x 0.375m  
Lid: Acrylic Glazing  
Pressure Treated



**Ladder Planter**  
Product Code: 25221

Size: W x D x H  
0.79m x 0.61m x 1.38m  
Sides: 120mm x 18mm  
Trough: 18mm Thick



7.5L  
Compost  
4x



**Vertical Herb Stand**  
Product Code: 00651

Size: W x D x H  
0.92m x 0.50m x 1.19m  
Frame: 40mm  
Timber: 100mm x 18mm  
Pressure Treated



6L  
Compost  
3x



**Tall Vertical Herb Stand**  
Product Code: 30181

Size: W x D x H  
0.59m x 0.37m x 1.39m  
Sides: 40mm Thick  
Trough: 20mm Thick  
Legs: 20mm Thick  
Pressure Treated



4.5L  
Compost  
5x



**Stepped Herb Planter**  
Product Code: 37236

Size: W x D x H  
0.83m x 0.96m x 0.85m  
Frame: 45mm x 70mm  
Timber: 87mm x 20mm  
Pressure Treated



14L  
Compost  
3x





## Composter

Product Code: 00348

Size: W x D x H  
1.0m x 1.0m x 0.6m

Sides: 18mm Thick  
Pressure Treated

395L  
Compost



## Eco Hive Composter

Product Code: 36096

Size: W x D x H  
0.75m x 0.82m x 0.96m

Frame: 28mm x 28mm  
Timber: 90mm x 20mm  
Lower Hatch: 500mm x 270mm  
Pressure Treated

405L  
Compost



New from **zest** for 2024



## Potting Bench

Product Code: 36105

Size: W x D x H  
0.89m x 0.48m x 0.93m

Frame: 42mm x 42mm  
Timber: 90mm x 18mm  
Table Top: 855mm x 475mm  
Pressure Treated



New from **zest** for 2024



# Sleeper Raised Beds

Suitable for growing fruit and vegetables or can be used as a raised bed for flowers.



## Sleeper Raised Bed - Wide

Product Code Size: W x D x H  
 00609 1.80m x 0.90m x 0.30m  
 00610 1.80m x 0.90m x 0.45m

Fascia: 60mm x 25mm  
 Sides: 100mm x 30mm  
 Pressure Treated



### Optional Extras:

Product Code	Description	Size
00313	Base	173m x 0.83m

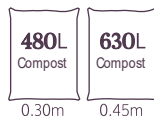

## Sleeper Raised Bed - Narrow

Product Code: 00608

Size: W x D x H  
 1.80m x 0.45m x 0.45m

Fascia: 60mm x 25mm  
 Sides: 100mm x 30mm  
 Pressure Treated



### Optional Extras:

Product Code	Description	Size
00312	Base	173m x 0.38m



## Sleeper Raised Bed - Square

Product Code: 00607

Size: W x D x H  
 0.90m x 0.90m x 0.45m

Fascia: 60mm x 25mm  
 Sides: 100mm x 30mm  
 Pressure Treated



### Optional Extras:

Product Code	Description	Size
00311	Base	0.83m x 0.83m



## Raised Bed

Product Code	Name	Size: W x D x H
25373	1m	1.0m x 1.0m x 0.25m
25372	1.8m	1.80m x 1.0m x 0.25m

Timber: 18mm  
 Pressure Treated

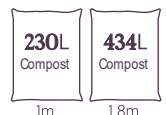



# Greenhouses

Zest's new range of Greenhouses, designed in the UK, are both stylish and space saving - perfect for every grow your own enthusiast.

A stylish addition to any garden, the space saving Tall Botanical Greenhouse combines stunning looks with all the functionality of a greenhouse. Fully glazed with Perspex to allow light through both roof and sides, the Botanical boasts two fully adjustable roof panels, with securing latches, allowing for optimal temperature control for all types of plants. It has **removable shelves which can also be reconfigured to a half width to allow for taller plants.**

## Tall Botanical Greenhouse

Product Code: 37678

Size: W x D x H

1.40m x 0.68m x 2.08m

Frame: 90mm x 40mm

T&G: 90mm x 20mm

Shelf Timber: 70mm x 20mm

Shelf Surface: 1190mm x 250mm (x6)

Pressure Treated



New from **zest** for 2024

The Compact Botanical Greenhouse, is a Perspex glazed, small space greenhouse, ideal for nurturing young plants. It has a sturdy wooden frame made from slow grown softwood sourced from responsibly managed PEFC forests. The compact greenhouse has hinged doors and an opening roof with dual height stays for optimum ventilation and comes complete with door catches and strategically placed drainage holes in the roof frame.

## Compact Botanical Greenhouse

Product Code: 36108

Size: W x D x H

0.85m x 0.40m x 1.23m

Frame: 35mm x 30mm

Shelf Timber: 40mm x 20mm

Shelf Surface: 814mm x 315mm (x2)

Pressure Treated



New from **zest** for 2024



# Planters & Shelving

Planters transform the garden with minimal effort. With a wide range to choose from, Zest offers ready built and self assembly planters in a variety of styles and sizes. The stylish planter sets and our Honeycomb Shelving are perfect for creating beautiful outdoor displays.



## Holywell Planter Set

Product Code: 00431

Product Code	Description	Size: W x D x H
00443	Large	0.60m x 0.60m x 0.65m
00493	Medium	0.47m x 0.47m x 0.52m
00613	Small	0.33m x 0.33m x 0.38m

Available as a set or individually  
 T&G: 12mm  
 Frame: 45mm x 45mm  
 Pressure Treated

147L Compost	63L Compost	17L Compost
Large	Medium	Small



## Gresford Planter Set

Product Code: 00402

Description	Size: W x D x H
Large	0.80m x 0.50m x 0.42m
Medium	0.70m x 0.40m x 0.32m
Small	0.60m x 0.30m x 0.28m

Available as a set only  
 Timber: 45mm x 35mm  
 Base: 90mm x 18mm  
 Pressure Treated

99L Compost	47L Compost	22L Compost
Large	Medium	Small



## Marford Hexagonal Planter Set

Product Code: 00492

Size:	W x D x H
Large:	0.60m x 0.60m x 0.30m
Medium:	0.45m x 0.45m x 0.26m
Small:	0.30m x 0.30m x 0.23m

Available as a set only  
 Timber: 35mm  
 Pressure Treated

50L Compost	28L Compost	15L Compost
Large	Medium	Small



## Chelsea Square Planter

Product Code: 29992

Size: W x D x H
0.60m x 0.60m x 0.37m
Timber: 80mm x 20mm
Frame: 45mm x 45mm
Base: 90mm x 20mm
Pressure Treated

63L Compost
----------------







### York Planter

Product Code: 00512

Size: W x D x H  
1.8m x 0.40m x 1.65m

Frame: 45mm x 45mm  
T&G: 90mm x 18mm  
Trellis: 25mm x 10mm  
Pressure Treated

207L  
Compost



### Cambridge Planter

Product Code: 00336

Size: W x D x H  
0.80m x 0.40m x 1.50m

Frame: 45mm x 45mm  
T&G: 90mm x 18mm  
Laths: 25mm x 10mm  
Pressure Treated

76L  
Compost



### Tiverton Planter

Product Code: 20779

Size: W x D x H  
0.40m x 0.20m x 0.17m

Pressure Treated



### Honeycomb Shelf Set of 3

Product Code: 29730

Size: W x D x H  
0.89m x 0.145m x 0.077m

Frame: 30mm x 30mm Shelf: 16mm Thick Pressure Treated



# Aquatic Planters

Zest's Aquatic Planters come complete with a polyvinyl chloride liner to create a stunning garden feature.



Product Code 09643 Size: W x H  
0.90m x 0.90m x 0.45m

Sides: 100mm x 30mm  
Fascia: 60mm x 25mm  
Pressure Treated



#### Optional Extras:

Product Code	Description	Size
00311	Base	0.83m x 0.83m

305L  
Water



Product Code 09644 Size: W x H  
1.80m x 0.90m x 0.30m

Sides: 100mm x 30mm  
Fascia: 60mm x 25mm  
Pressure Treated



#### Optional Extras:

Product Code	Description	Size
00313	Base	1.73m x 0.83m

480L  
Water  
0.30m



Product Code 09645 Size: W x H  
1.80m x 0.90m x 0.45m

Sides: 100mm x 30mm  
Fascia: 60mm x 25mm  
Pressure Treated



#### Optional Extras:

Product Code	Description	Size
00312	Base	1.73m x 0.38m

340L  
Water





# Outdoor Storage

Offering the perfect space saving solution in outdoor storage. Log stores are designed to keep logs ready for the colder months.



**Parcel Store with Planter**  
Product Code: 31319

**Size: W x D x H**  
0.50m x 0.57m x 0.69m  
Sides: 90mm x 20mm  
Frame: 35mm x 30mm  
Roof: 90mm x 20mm - Feather Edge  
Floor: 90mm x 20mm  
Pressure Treated

6.5L  
Compost



**Keep Safe Parcel Store**  
Product Code: 31317

**Size: W x D x H**  
0.58m x 0.44m x 0.84m  
Sides: 90mm x 20mm  
Frame: 35mm x 30mm  
Roof: 90mm x 20mm - Feather Edge  
Floor: 90mm x 20mm  
Pressure Treated



**Log Chest**  
Product Code: 25250

**Size: W x D x H**  
1.80m x 0.72m x 0.84/0.76m  
Sides: 25mm x 18mm  
Frame: 35mm x 28mm  
Roof: 11mm - Feather Edge  
Floor: 25mm x 18mm  
Pressure Treated



**Log Store**  
Product Code: 25251

**Size: W x D x H**  
1.2m x 0.58m x 1.5m  
Sides: 18mm Thick  
Roof: 11mm - Feather Edge  
Back / Brace: 25mm x 18mm  
Pressure Treated







# Arches

Functional and elegant, arches are an attractive feature in any outdoor space and garden, providing height to create a focal point. Zest's variety of arches, include those with adjustable widths, giving total flexibility.



## Venus Arch

Product Code: 00039

Size: W x D x H  
1.80m x 1.06m x 2.10m

Posts: 90mm x 90mm

Rafters: 90mm x 45mm

Trellis: 30mm x 10mm

Internal Width: 1400mm

Fencing accessory No. 3e / 4d  
Pressure Treated







### Daria Arch

Product Code: 00361

Size: W x D x H  
1.80m x 0.90m x 2.40m

Posts: 70mm x 70mm  
Rafters: 70mm x 30mm  
Bowed Rafter:  
70mm x 30mm Glue Laminated  
Trellis: 30mm x 10mm  
Adjustable Width  
Fencing Accessory No. 3d / 4c  
Pressure Treated



### Horizon Arch

Product Code: 00042

Size: W x D x H  
1.80m x 1.30m x 2.20m

Posts: 90mm x 90mm  
Rafters: 90mm x 45mm  
Trellis: 30mm x 10mm  
Adjustable Width  
Fencing Accessory No. 3e / 4d  
Pressure Treated



### Starlight Arch

Product Code: 00002

Size: W x D x H  
1.34m x 0.72m x 2.23m

Posts: 70mm x 70mm  
Trellis: 30mm x 10mm  
Internal Width: Adjustable  
Top Beam:  
70mm x 35mm Bowed Rafter  
Rafters: 70mm x 35mm  
Fencing Accessory No. 3d / 4c  
Pressure Treated



### Twilight Arch

Product Code: 00001

Size: W x D x H  
2.10m x 0.72m x 2.13m

Posts: 70mm x 70mm  
Rafters: 70mm x 35mm  
Trellis: 30mm x 10mm  
Adjustable Width  
Fencing Accessory No. 3d / 4c  
Pressure Treated



### Sunset Arch

Product Code: 00040

Size: W x D x H  
1.60m x 0.55m x 2.12m

Posts: 40mm x 40mm  
Rafters: 50mm x 17mm  
Trellis: 20mm x 10mm  
Adjustable Width  
Fencing Accessory No. 5a  
Pressure Treated







# Landscaping

Zest's range of Trellis, Climbing Supports, Fencing & Gates, Posts, Decking, Sleepers and Edging come in a variety of sizes and styles to suit all garden needs.

## Trellis & Obelisk Range

Trellis & Obelisks are ideal for separating sections of the garden, dressing garden paths and offering climbing plants and flowers support to create an idyllic garden feature. Zest's Trellis panels come in a variety of sizes and styles.

### Fan Trellis

Product Code	Size: W x H
24206	0.43m x 0.91m
24207	0.53m x 1.22m
24208	0.53m x 1.52m
24209	0.63m x 1.83m

Battens: 32mm x 16mm  
Pressure Treated



### Hillside Fan Trellis

Product Code	Size: W x H
00417	0.60m x 1.83m
00418	0.80m x 1.83m

Frame: 30mm x 30mm par  
Laths: 20mm x 8mm par  
Spacing: 40mm average  
Pressure Treated





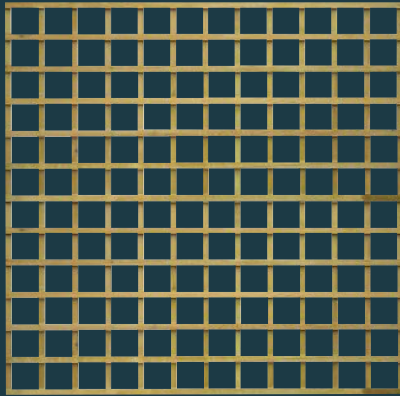

## 110mm Square Trellis

Product Code	Size: W x H
24205	1.83m x 0.305m
24197	1.83m x 0.615m
24198	1.83m x 0.915m
24199	1.83m x 1.220m
24201	1.83m x 1.524m
24204	1.83m x 1.830m

Battens: 32mm x 16mm  
Spacing: 110mm average  
Pressure Treated

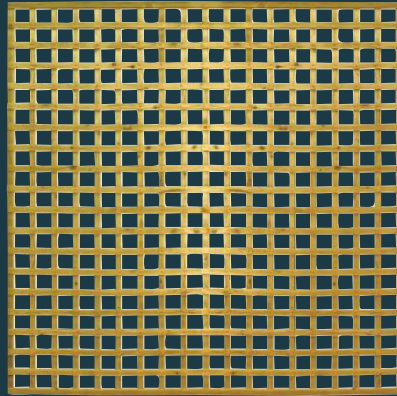

## County Square Trellis

Product Code	Size: W x H
00351	1.83m x 0.305m
00352	1.83m x 0.615m
00353	1.83m x 0.915m
00354	1.83m x 1.220m
00355	1.83m x 1.524m
00356	1.83m x 1.830m

Laths: 30mm x 12mm par  
Spacing: 65mm average  
Pressure Treated

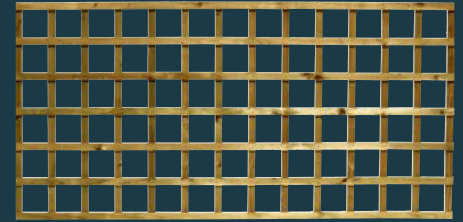

## Kingston Square Trellis

Product Code	Size: W x H
20814	1.83m x 0.30m
20815	1.83m x 0.60m
20816	1.83m x 0.90m

Battens: 30mm x 15mm par  
Spacing: 110mm average  
Pressure Treated

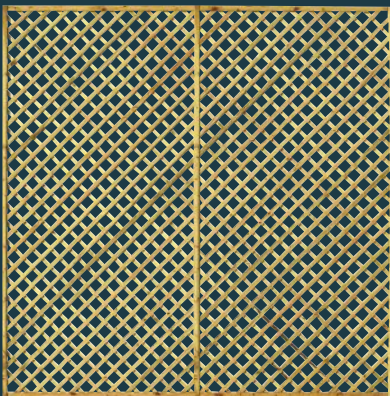

## Hillside Diamond Trellis

Product Code	Size: W x H
00419	1.83m x 0.30m
00420	1.83m x 0.60m
00421	1.83m x 0.90m
00422	1.83m x 1.20m
00423	1.83m x 1.50m
00424	1.83m x 1.80m

Frame: 30mm x 30mm par  
Laths: 20mm x 8mm par  
Spacing: 40mm average  
Pressure Treated  
Centre Bar on 180m & 150m only

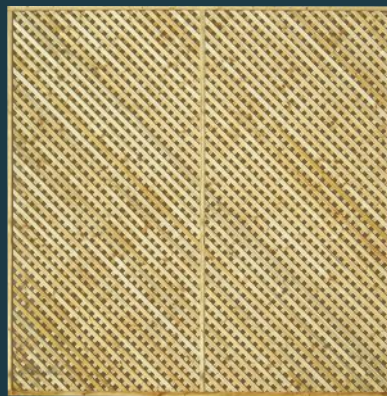

## Privacy Diamond Trellis

Product Code	Size: W x H
00550	1.83m x 0.30m
00551	1.83m x 0.60m
00552	1.83m x 0.90m
00553	1.83m x 1.20m
00554	1.83m x 1.50m
00555	1.83m x 1.80m

Frame: 30mm x 30mm par  
Laths: 20mm x 8mm par  
Centre Bar on 180m & 150m only  
Spacing: 20mm average  
Pressure Treated

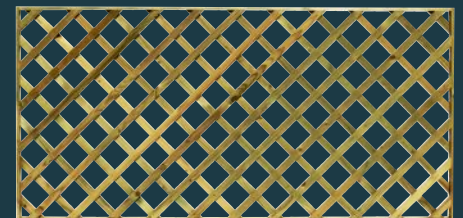

## Richmond Diamond Trellis

Product Code	Size: W x H
20811	1.83m x 0.30m
20812	1.83m x 0.60m
20813	1.83m x 0.90m

Frame: 30mm x 15mm par  
Batten: 30mm x 15mm par  
Spacing: 85mm average  
Pressure Treated







### Hillside Omega Trellis Top

Product Code 00425    Size: W x H  
 1.83m x 0.28 / 0.48m  
 Frame: 30mm x 30mm par  
 Laths: 20mm x 8mm par  
 Spacing: 40mm average  
 Pressure Treated



### Hillside Convex Trellis Top

Product Code 00416    Size: W x H  
 1.83m x 0.28 / 0.425m  
 Frame: 30mm x 30mm par  
 Laths: 20mm x 8mm par  
 Spacing: 40mm average  
 Pressure Treated



### Hillside Concave Trellis Top

Product Code 00415    Size: W x H  
 1.83m x 0.28 / 0.14m  
 Frame: 30mm x 30mm par  
 Laths: 20mm x 8mm par  
 Spacing: 40mm average  
 Pressure Treated

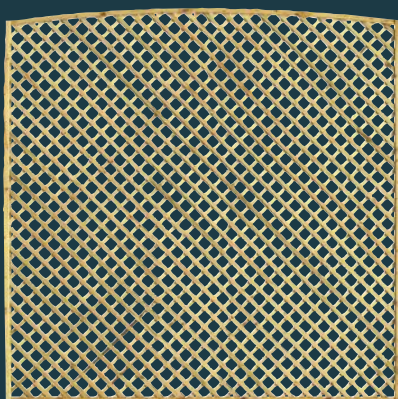

### Hillside Bowtop Diamond Trellis

Product Code    Size: W x H  
 00320    1.83m x 0.20 / 0.30m  
 00321    1.83m x 0.50 / 0.60m  
 00322    1.83m x 0.80 / 0.90m  
 00323    1.83m x 1.10 / 1.20m  
 00324    1.83m x 1.40 / 1.50m  
 00325    1.83m x 1.70 / 1.80m  
 Frame: 30mm x 30mm par  
 Laths: 20mm x 8mm par  
 Spacing: 40mm average  
 Pressure Treated



### Snowdon Obelisk

Product Code: 00614

Size: W x D x H  
 0.6m x 0.6m x 2.0m



### Scafell Obelisk

Product Code: 00593

Size: W x D x H  
 0.39m x 0.39m x 1.2m





# British & European Fencing & Gates



## San Remo Omega Panel with Trellis

Product Code    Size: W x H  
 00586            1.83m x 0.70 / 0.90m  
 00587            1.83m x 0.99 / 1.20m  
 00588            1.83m x 1.30 / 1.50m  
 00589            1.83m x 1.60 / 1.80m  
 Frame: 45mm x 39mm  
 Laths: 90mm x 10mm  
 Battens: 40mm x 10mm  
 Trellis: 30mm x 10mm  
 Spacing between Trellis: 50mm  
 Pressure Treated



## San Remo Bowtop with Trellis

Product Code    Size: W x H  
 00576            1.83m x 0.70 / 0.90m  
 00577            1.83m x 1.59 / 1.79m  
 Frame: 45mm x 39mm  
 Laths: 90mm x 10mm  
 Battens: 40mm x 10mm  
 Trellis: 30mm x 10mm  
 Spacing between Trellis: 100mm  
 Pressure Treated



## San Remo Bowtop

Product Code    Size: W x H  
 00574            1.83m x 0.99 / 1.20m  
 00578            1.83m x 1.29 / 1.50m  
 00575            1.83m x 1.59 / 1.79m  
 Frame: 45mm x 39mm  
 Laths: 90mm x 10mm  
 Battens: 40mm x 10mm  
 Pressure Treated



## San Remo Omega Gate

Product Code    Size: W x H  
 00590            0.90m x 1.59 / 1.80m  
 Frame: 88mm x 44mm  
 Laths: 90mm x 10mm  
 Battens: 40mm x 10mm  
 Trellis: 30mm x 10mm  
 Pressure Treated



## San Remo Bowtop Gate with Trellis

Product Code    Size: W x H  
 00579            0.90m x 1.59 / 1.80m  
 Frame: 88mm x 44mm  
 Laths: 90mm x 10mm  
 Battens: 40mm x 10mm  
 Trellis: 30mm x 10mm  
 Pressure Treated



## San Remo Bowtop Gate

Product Code    Size: W x H  
 00580            0.90m x 1.59 / 1.80m  
 Frame: 88mm x 44mm  
 Laths: 90mm x 10mm  
 Battens: 40mm x 10mm  
 Pressure Treated





Our British & European Fencing is made from high quality, pressure treated or dipped timber, creating an attractive finish to products making them both durable and long lasting.



### San Remo Flat Top with Trellis

**Product Code**    **Size: W x H**  
 00584            1.83m x 0.90m  
 00585            1.83m x 1.80m  
 Frame: 45mm x 39mm  
 Trellis: 30mm x 10mm  
 Laths: 90mm x 10mm  
 Battens: 40mm x 10mm  
 Spacing between Trellis: 50mm  
 Pressure Treated



### San Remo Flat Top

**Product Code**    **Size: W x H**  
 00583            1.83m x 1.80m  
 Frame: 45mm x 39mm  
 Laths: 90mm x 10mm  
 Battens: 40mm x 10mm  
 Pressure Treated



### Hit & Miss Fence Panel

**Product Code**    **Size: W x H**  
 38401            1.83m x 0.90m  
 38400            1.83m x 1.20m  
 38399            1.83m x 1.50m  
 38398            1.83m x 1.80m  
 Frame: 45mm x 18mm  
 Laths: 45mm x 18mm  
 Pressure Treated



### San Remo Flat Top Gate with Trellis

**Product Code**    **Size: W x H**  
 00582            0.90m x 1.80m  
 Frame: 88mm x 44mm  
 Laths: 90mm x 10mm  
 Battens: 40mm x 10mm  
 Trellis: 30mm x 10mm  
 Pressure Treated



### San Remo Flat Top Gate

**Product Code**    **Size: W x H**  
 00581            0.90m x 1.80m  
 Frame: 88mm x 44mm  
 Laths: 90mm x 10mm  
 Battens: 40mm x 10mm  
 Pressure Treated



### Gate Accessory Kit

**Product Code**  
 00398  
 Includes ring latch, set of T hinges, brenton bolt and fixings. Suitable for garden side gates – ask for details. All galvanised.







## Bowtop Vertical Board Fence

Product Code	Size: W x H
00330	1.83m x 0.615m
00331	1.83m x 0.915m
00332	1.83m x 1.220m
00333	1.83m x 1.524m
00334	1.83m x 1.830m

Feather Edge Boards: 25mm Wide  
 Capping: 30mm x 8mm Flexible  
 Backing Rail: 75mm x 22mm  
 Pressure Treated



## Vertical Board Fence

Product Code	Size: W x H
00639	1.83m x 0.615m
00640	1.83m x 0.915m
00641	1.83m x 1.220m
00642	1.83m x 1.524m
00643	1.83m x 1.830m

Feather Edge Boards: 25mm Wide  
 Backing Rail: 75mm x 22mm  
 Capping: 40mm x 10mm Bevelled Edges  
 Pressure Treated



## Waney Lap

Product Code	Size: W x H
00657	1.83m x 0.615m
00658	1.83m x 0.915m
00659	1.83m x 1.220m
00660	1.83m x 1.524m
00661	1.83m x 1.830m

Battens: 32mm x 16mm  
 Capping: 40mm x 10mm Bevelled Edges  
 Frame: 4 Vertical & 2 Horizontal on both sides  
 Laths: 25mm x 4.5mm Average



ALL SIZES THAT ARE HIGHLIGHTED ARE NON-STOCKED ITEMS. MADE TO ORDER WITH EXTENDED DELIVERY LEAD TIME.



## Bowtop Vertical Board Gate

Product Code	Size: W x H
00326	0.91m x 0.915m
00327	0.91m x 1.220m
00328	0.91m x 1.524m
00329	0.91m x 1.830m

Frame: 45mm x 39mm Laths: 90mm x 10mm  
 Battens: 40mm x 10mm Pressure Treated



## Vertical Board Gate

Product Code	Size: W x H
00634	0.91m x 0.915m
00635	0.91m x 1.220m
00636	0.91m x 1.524m
00637	0.91m x 1.830m

Feather Edge Boards: 25mm Wide  
 Frame: 75m x 22mm  
 Capping: 40mm x 10mm Bevelled Edges  
 Pressure Treated Battens: 40mm x 10mm  
 Pressure Treated



## Waney Lap Gate

Product Code	Size: W x H
00652	0.91m x 0.915m
00653	0.91m x 1.220m
00654	0.91m x 1.524m
00655	0.91m x 1.830m

Frame: 75m x 22mm  
 Laths: 25mm x 4.5mm Average  
 Capping: 40mm x 10mm Bevelled Edges







## Rounded Top Picket Pale Fence

Product Code	Size: W x H
00565	1.83m x 0.30m
00566	1.83m x 0.60m
00567	1.83m x 0.90m
00568	1.83m x 1.20m

Pales: 70mm x 14mm  
 Backing Rail: 70mm x 18mm  
 Gap between Boards: 55mm  
 Pressure Treated



## Old Picket Fence (Fine Sawn)

Product Code	Size: W x H
00509	1.83m x 0.60m
00510	1.83m x 0.90m
00511	1.83m x 1.20m

Pales: 75mm x 16mm  
 Backing Rail: 75mm x 22mm  
 Gap between Boards: 55mm



ALL SIZES THAT ARE HIGHLIGHTED ARE NON-STOCKED ITEMS. MADE TO ORDER WITH EXTENDED DELIVERY LEAD TIME.



## Rounded Top Picket Pale Gate

Product Code	Size: W x H
00569	0.90m x 0.90m
00570	0.90m x 1.20m

Pales: 70mm x 14mm  
 Backing Rail: 70mm x 18mm  
 Gap between Boards: 55mm



## Old Picket Gate (Fine Sawn)

Product Code	Size: W x H
00391	0.91m x 0.90m
00392	0.91m x 1.20m

Pales: 75mm x 16mm  
 Backing Rail: 75mm x 22mm  
 Gap between Boards: 55mm





# Posts

Zest's posts are made from high quality timber and pressure treated to provide the best protection against the weather all year round. The posts are designed to be used with the Zest range of fencing and trellis.



## Post 47mm x 47mm

Product Code	Size: L x W x D
00044	1.2m x 47mm x 47mm
00050	1.5m x 47mm x 47mm
00059	1.8m x 47mm x 47mm
00078	2.1m x 47mm x 47mm
00087	2.4m x 47mm x 47mm

Softwood  
Square End Cut  
Pressure Treated

**PT** Manufactured using FSC® certified timber



## Post 75mm x 75mm

Product Code	Size: L x W x D
00045	1.2m x 75mm x 75mm
00051	1.5m x 75mm x 75mm
00061	1.8m x 75mm x 75mm
00079	2.1m x 75mm x 75mm
00089	2.4m x 75mm x 75mm
00092	2.7m x 75mm x 75mm

Softwood  
Square End Cut  
Pressure Treated

**PT**  Manufactured using FSC® certified timber



## Post 95mm x 95mm

Product Code	Size: L x W x D
00062	1.8m x 95mm x 95mm
00080	2.1m x 95mm x 95mm
00090	2.4m x 95mm x 95mm

Softwood  
Square End Cut  
Pressure Treated

**PT**  Manufactured using FSC® certified timber



## Planed Post

Product Code	Size: L x W x D
00517	1.8m x 70mm x 70mm
00518	2.4m x 70mm x 70mm
00519	1.8m x 90mm x 90mm
00520	2.4m x 90mm x 90mm

Softwood  
Rounded Top Post  
Pressure Treated



**PT**



## Round Post 60mm & 75mm

Product Code	Size: L x W x H	Product Code	Size: L x W x H
00055	1.80m x 60mm	00047	1.35m x 75mm
00075	2.10m x 60mm	00054	1.65m x 75mm
00081	2.40m x 60mm	00056	1.80m x 75mm
		00076	2.10m x 75mm
		00082	2.40m x 75mm

Pointed - 4 way  
Machined Finish  
Pressure Treated

**PT**





### Post Cap

Product Code 00119  
 Size: W x H 75mm x 75mm  
 00125 95mm x 95mm  
 Chamfered Edge  
 Pressure Treated



### Ball Finial

Product Code 00310  
 Size: W x D x H 90mm x 65mm x 65mm  
 Pressure Treated



### Acorn Finial

Product Code 00290  
 Size: W x D x H 120mm x 65mm x 65mm  
 Pressure Treated

PT



### Support Stakes

Product Code 00628  
 Size: W x D x H 600mm x 47mm x 47mm  
 Pointed  
 Pressure Treated

PT



### Square Tree Stakes

Product Code 00043  
 Size: L x W x H 1.2m x 32mm x 32mm  
 00049 1.5m x 32mm x 32mm  
 00057 1.8m x 32mm x 32mm  
 00077 2.1m x 32mm x 32mm  
 00085 2.4m x 32mm x 32mm  
 Softwood  
 Pointed - 2 way  
 Pressure Treated

PT



### Gravel Board

Product Code 00399  
 Size: L x W x D 1.828m x 125mm x 22mm  
 00400 1.828m x 150mm x 22mm  
 Square End Cut  
 Pressure Treated



PT

PT



Manufactured using FSC® certified timber



# Edging Systems

The Zest range of edging is elegant and sturdy to stand the test of time. Providing a low maintenance way of edging to create the perfect finish to any garden.



## Log Roll

Product Code	Size: W x H
00468	1.8m x 150mm
00469	1.8m x 225mm
00470	1.8m x 300mm
00471	1.8m x 380mm

Half Round Logs: 70mm Chamfered Top  
Pressure Treated



**PT**



## Log Panel

Product Code	Size: W x H
00459	1.0m x 150mm
00460	1.0m x 225mm
00461	1.0m x 300mm

Half Round Logs: 70mm Chamfered Top  
Pressure Treated



**PT**



## Horizontal Log Edging

Product Code	Size: W x H
00434	1.0m x 210mm

Half Round Logs: 70mm  
Support Batten: 25mm x 16mm  
Pressure Treated



**PT**



## Mini Pickets

Product Code	Size: W x H
00499	1.15m x 280mm

Pales: 70mm x 16mm  
Support Battens: 30mm x 16mm  
Rounded Tops  
Pressure Treated



**PT**



# Sleepers

Using Zest sleepers is a practical way to create sturdy raised beds or borders, providing an on-trend, low maintenance aspect to any garden.

## Sleepers

Product Code    Size: W x D x H  
 00604            0.9m x 0.20m x 0.10m  
 00605            1.8m x 0.20m x 0.10m  
 00603            2.4m x 0.20m x 0.10m  
 Square End Cut  
 New Timber, Not Reclaimed  
 Pressure Treated

**PT**



Pack of Sleepers



## Rustic Sleepers

Product Code    Size: W x D x H  
 00572            2.4m x 0.15m x 0.10m  
 Sawn Cut on Two Sides  
 Barked Finish on Two Sides  
 Pressure Treated

**PT**



Pack of Sleepers





### 1. Fin Grip Spike



Galvanised Steel

<b>No.</b>	<b>Size: W x D x H</b>
1a Product Code: 00121	75 x 75 x 600mm
1b Product Code: 00122	75 x 75 x 750mm
1c Product Code: 00066	100 x 100 x 750mm

### 2. Plain Box Spike



Galvanised Steel

<b>No.</b>	<b>Size: W x D x H</b>
2a Product Code: 00109	50 x 50 x 450mm

### 3. Bolt Grip Spike



Galvanised Steel

<b>No.</b>	<b>Size: W x D x H</b>
3a Product Code: 00116	75 x 75 x 600mm
3b Product Code: 00117	75 x 75 x 750mm
3c Product Code: 00068	100 x 100 x 750mm
3d Product Code: 00112	72 x 72 x 600mm
3e Product Code: 00124	92 x 92 x 750mm

### 4. Bolt Grip Bolt Down



Galvanised Steel

<b>No.</b>	<b>Size: W x D x H</b>
4a Product Code: 00113	75 x 75mm
4b Product Code: 00064	100 x 100mm
4c Product Code: 00111	72 x 72mm
4d Product Code: 00123	92 x 92mm

### 5. Plain Box Bolt Down



Galvanised Steel

<b>No.</b>	<b>Size: W x D x H</b>
5a Product Code: 00108	50 x 50mm

### 6. Fin Grip Concrete In



Galvanised Steel

<b>No.</b>	<b>Size: W x D x H</b>
6a Product Code: 00114	75 x 75mm
6b Product Code: 00063	100 x 100mm

### 7. Fin Grip Repair Spur



Galvanised Steel

<b>No.</b>	<b>Size: W x D x H</b>
7a Product Code: 00120	75 x 75mm
7b Product Code: 00067	100 x 100mm

### 8. Post Extender



Galvanised Steel

<b>No.</b>	<b>Size: W x D x H</b>
8a Product Code: 00115	75 x 75mm
8b Product Code: 00065	100 x 100mm

### 9. U Clip



Galvanised Steel  
Bucket of 250

<b>No.</b>	<b>Size: W x D x H</b>
9a Product Code: 00105	41mm
9b Product Code: 00106	46mm
9c Product Code: 00110	52mm

### 10. Driving Tool



High Impact Plastic

<b>No.</b>	<b>Size: W x D x H</b>
10a Product Code: 00372	75mm

### 11. Arris Rail Bracket

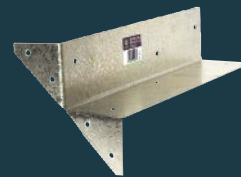

Galvanised Steel  
Bucket of 50

<b>No.</b>	<b>Size: W x D x H</b>
11a Product Code: 00300	220mm

### 12. Gravel Board Clip



Galvanised Steel  
Bucket of 50

To suit board  
thickness up  
to 25mm

<b>No.</b>	<b>Product Code:</b>
12a	00107

### 13. Border Roll Pin



Galvanised Steel

<b>No.</b>	<b>Size:</b>
13a Product Code: 00319	457mm

### 14. L Clip



Galvanised Steel  
Bucket of 200

<b>No.</b>	<b>Size:</b>
14a Product Code: 00440	45mm